



OWNER'S MANUAL

HI-200A1 2 PERSON SAUNA



FOR INDOOR USE ONLY

120 Volt system, 20 amps

Infrared carbon ceramic sauna.

LTR.2024.1007

Rev 1.0



Welcome

Thank you for purchasing a Cal Sauna brand sauna, an industry leader in outdoor resort products. Thoroughly read the instructions and warnings contained in this user manual. Please follow all instructions inside this manual, to have the best experience with your Cal Sauna!



Important Safety Information:

This Sauna is designed to operate on a 120v 20 amp circuit.

Visually inspect all panels and cables before assembly. Inspect for any shipping damages or damage to the heating element, **DO NOT START THE SAUNA IF DAMAGE IS OBSERVED ON THE CABLES OR HEATING ELEMENT.** Contact your dealer or contact Cal Sauna for troubleshooting or replacement parts.

NOTICE: This sauna is designed for indoor use only. Please do not expose the sauna to the outdoors, rainfall, or excess moisture, failure to do so can result in injury or lead to the risk of a fire.

WARNING: Do not open the power control unit "PCU"/control box, manipulating or disassembling the unit can lead to electric shock or a fire risk. The PCU/control box should only be opened, repaired, or replaced by a certified technician or electrician.



Caution

Important Safety Information:

This Cal Sauna sauna is not intended for use by individuals (including children) with reduced movement, chronic health issues, or sensory/physical disabilities. Children must be supervised or accompanied by an adult when sauna is in use.

Warning!: Exposure to high temperatures over an extended period of time can lead to dehydration and hyperthermia. Individuals with underlying conditions such as obesity, high cholesterol, diabetes, high blood pressure, heart problems or other chronic health conditions should ask a medical professional to determine a safe heat exposure limit. Healthy individuals should monitor their usage of the sauna, it is recommended to wait about 30 minutes after strenuous exercise before using the sauna.

Warning!: Pregnant women should contact a medical professional in regard to using a sauna, exposure to excessive heat for an extended period of time can cause harm to the fetus.

EXIT THE SAUNA IMMEDIATELY IF YOU FEEL DIZZY, DROWSY, OR ANY DISCOMFORT.

Do not enter the sauna if under the influence of alcohol, drugs, or prescription medication. Excessive heat under the influence can cause disorientation, drowsiness, dehydration, unconsciousness, or cause a heat stroke.

Warning!: This sauna must be placed on a level ground, failure to do so can lead to splintered/bent hinges, compromising the integrity of the walls, damage caused from uneven ground is not covered under warranty.

●●● Table Of Contents

Important information.....	2
What are Infrared “IR” rays?.....	4
Important installation instructions.....	7
Packaging and Panel Information.....	8
Sauna Diagram.....	10
Assembly Instructions.....	10
Digital Controller Legend.....	16
Sauna Start up.....	17
Operating the sauna.....	17
Tips and Additional Sauna Safety.....	18
Circuit Reset and Diagram.....	21
Limited Warranty.....	22

What Are Infrared Rays

Infrared light is a band of light that we cannot see, but it is something we can perceive as heat. The sun produces most of its energy output in the infrared segment of the spectrum which becomes the warmth we can feel in the daytime, the same light energy that allows life to thrive. Infrared light is generally measured in 3 segments based on its wavelength: near infrared, middle infrared, and far infrared. Infrared light can deeply penetrate organic tissue to give your body deep therapeutic warming. This helps with muscle fatigue and joint pain, you can use this sauna as a part your daily routine or to help you recover after exercise.

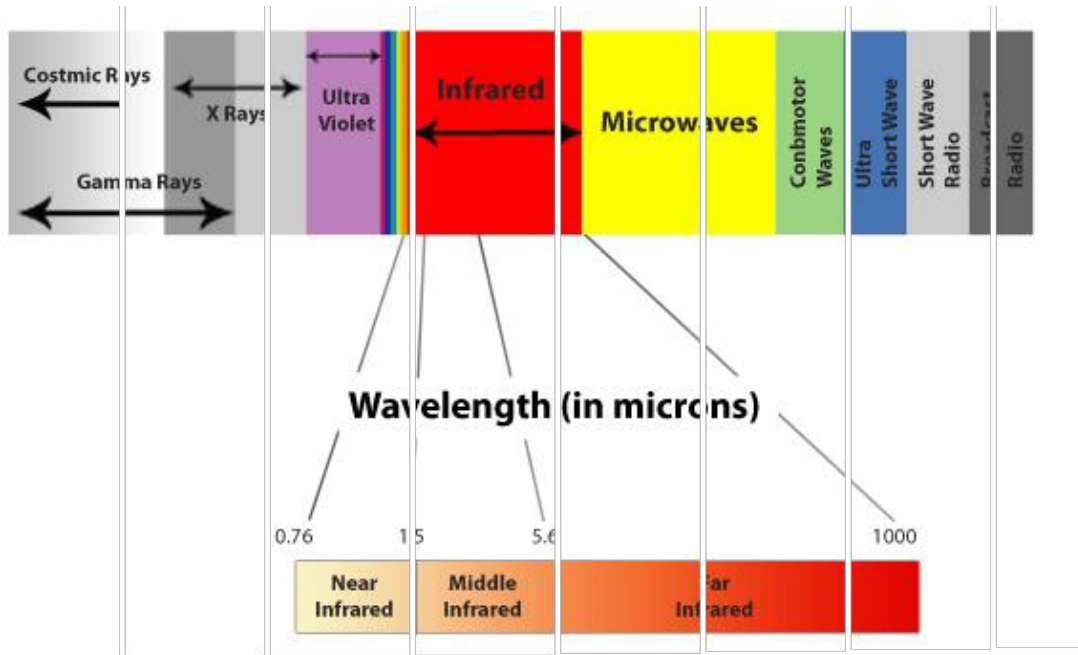

ARE INFRARED RAYS SAFE?

The light energy that we encounter on earth from the sun is ultraviolet light and infrared light. Although the sun releases energy across the whole spectrum, unlike UV light, infrared light does not cause any cell damage or sunburns compared to UV light. Infrared light is used in many medical applications including incubators for newborns and eggs. The benefit of infrared light is in its wavelength, these light waves can penetrate deep tissue to help promote blood flow and to relax tense muscles after a rigorous workout, while being completely safe on the human body.

WHAT IS AN ELECTROMAGNETIC FIELD (also known as EMF)?

An electromagnetic field is a force field produced by electrically charged objects. It is one of the fundamental forces of nature. A magnetic field is composed of multiple magnetic charges that work off of one another. Our saunas are built with low magnetic field interference with an average range of 5mG-10mG at around 2 inches from the carbon heaters

EMF Levels from Common Homes Sources

SOURCE	mG up to 4 inches	mG at 3 feet
Blender	50-220	0.3-3
Clothes Washer	8-200	0.1-4
Coffee Maker	6-29	0.1
Computer	4-20	2-5
Flourescent Lamp	400-4,000	0.1-5
Hair Dryer	60-20,000	0.1-6
Microwave Oven	100-500	1-25
Television	5-100	0.1-6
Vacuum Cleaner	230-1,300	3-40
Airplane	50	

Source: USA Environmental Protection Agency

The table above shows examples of different sources of EMF's in a persons common surroundings. Our saunas only generate 5mG-10mG about 2 inches above the carbon heater. Currently there is no consensus on the potential health hazards from exposure to EMF's. Available evidence suggests that low-power, low frequency, electromagnetic radiation commonly associated with household appliances and currents do not constitute any short or long term health hazards.

DISCLAIMER

The infrared rays emitted by your sauna helps provide heat therapy to your entire body. Heat therapy is a concept shared across many cultures for thousands of years. These mentioned benefits are for reference only and are not meant to imply that our saunas will cure or treat chronic diseases or directly treat symptoms of chronic health issues. Please consult with a medical professional before using a sauna if you have any underlying health problems. Persons with surgical implants (pins, rods, artificial joints, silicone, etc) may speak with a medical professional before using the sauna, although most users with implants do not encounter issues. Irregular heating can cause slight discomfort around the implant area if the operation was recent.

HOW IT WORKS

Infrared saunas are different from traditional saunas in the methods of generating heat. Traditionally saunas used hot steam or heat from hot ashes/coins to heat the sauna chamber slowly bringing it up to temperature. Cal Sauna uses a industry leading carbon ceramic heating element to radiate heat energy over the entire chamber to provide faster heat up times, and efficient operation.

The sauna reaches ideal temperature around 30-45min after activation, with an ambient temp of 60F or higher

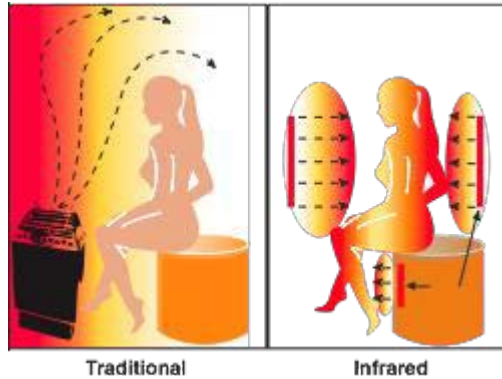

Health Benefits

Infrared light heats the body through the process called conversion, creating a deep heating effect to help soothe muscles and joints, similar to how rubbing or massaging a muscle after an intense work out works, you are introducing heat to help recover. Our bodies react to heat by sweating, our sweat contains waste material that our immune system and liver collects. Naturally sweat often contains collected waste/oils, excess sodium, toxins from alcohol consumption, and even heavy metals. Saunas have been used for hundreds of years to not only promote sweating to help remove waste in the human body, but to tone and cleanse a persons skin as well. When we sweat due to excess heat the body opens up the pores in our skin to help release more sweat to keep us cool. In the process oils and contaminants in our pores are expelled in our sweat and helps our skin become more elastic. The infrared heat created by a sauna also helps promote blood circulation to bring out the color and glow of your skin.

Health Benefits Include, But Are Not Limited To:

- *Arthritis Pain Relief *Relax injured muscles *Reduces Cellulite
- *Increased Blood Circulation *Clears Pores *Enhances Skin Tone
- *Cardiovascular Conditioning *Help Reduce Stress *Removes Excess Toxins

Maintenance

Cal Sauna infrared saunas are not built with a traditional hot rock furnace or steam generator, therefore maintenance on this unit is very simple compared to old traditional systems. We would recommend using only tap water on a damp towel, we do not recommend using any chemicals on the wood. The wood inside of the sauna can absorb chemicals/oils from common cleaners and can release fumes from these cleaners once the sauna is in use.

When using the sauna we recommend folding a towel to sit upon, this helps collect sweat and provides a cushion for you while using the sauna.





Important installation instructions:

This sauna is an indoor sauna designed for personal recreational use. Cal Sauna saunas are not intended for outdoor or commercial use. Malfunctions/Damage incurred from commercial or outdoor use is not covered under warranty.

Electrical Specifications: This sauna is designed to operate on an independent 120 Volt 20 amp circuit. **DO NOT CONNECT THIS SAUNA TO A SHARED OUTLET.**

Do not open the PCU/Electrical box, only a technician should open/replace this component, improper installation or manipulation can cause an electrical fire.

Caution: Do not assemble this sauna if it is not in its intended resting place. Moving the sauna after it is built can cause fractures on freshly screwed panels and damage to the locking hinges.

Caution: Visually inspect all panels and cables before assembly. Inspect for any shipping damages or damage to the heating element, **DO NOT START THE SAUNA IF DAMAGE IS OBSERVED ON THE CABLES OR HEATING ELEMENT.** Contact your dealer or contact Cal Sauna for troubleshooting or replacement parts.

Caution: Two or more persons are needed to build this unit safely. DO NOT ASSEMBLE ALONE/WITHOUT ASSISTANCE.

Caution: This sauna must be placed on a level ground, failure to do so can lead to splintered/bent hinges, compromising the integrity of the walls, damage caused from uneven ground is not covered under warranty.

Caution: Keep in a dry location, the wooden panels of this sauna are made of untreated softwood, in particular softwood works great to insulate your sauna due to its density, but it will easily absorb water and moisture from its surroundings. Keep the base and exterior of the sauna dry, away from sources of moisture.

Sauna Packaging and Individual Panel Information

Our Cal Saunas are shipped in several separate boxes, depending on the model there can be between 2-3 boxes required to assemble your unit.

Refer to the table below to ensure you have all boxes needed to assemble your Cal Sauna.

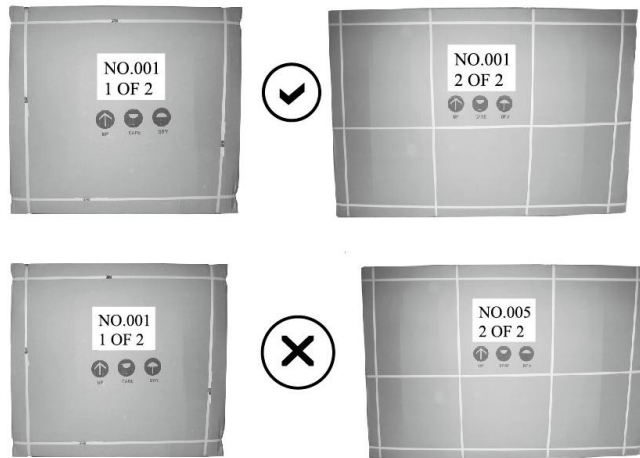









NOTE: Please verify that all packages have the same NO number. If they are mismatched please contact your dealer.

All Cal Saunas heaters are pretested before packaging. A minimum of two people are required to assemble this unit as some of the wall panels weigh up to 80Lbs.

Parts list of a sauna room	
Bottom Panel	Top Panel
Back Panel	Bench Panel
Right Panel	Bench Heater Panel
Left Panel	Accessories
Front Panel	

Below are pictures of individual panels for the 2-person model. Other models vary.

Front Panel	Bottom Panel
	
Top Panel	Back Panel
	 <p data-bbox="971 947 1143 974">Ceramic heater</p>
Left Panel	Right Panel
 <p data-bbox="477 1415 639 1442">Carbon heater</p>	 <p data-bbox="974 1415 1136 1442">Carbon heater</p>
Bench Panel	Bench Heater Panel
	 <p data-bbox="974 1730 1136 1757">Carbon heater</p>

CAUTION: DO NOT ASSEMBLE WITHOUT ASSISTANCE

DO NOT PLUG OTHER APPLIANCES ON THE SAME OUTLET AS YOUR SAUNA

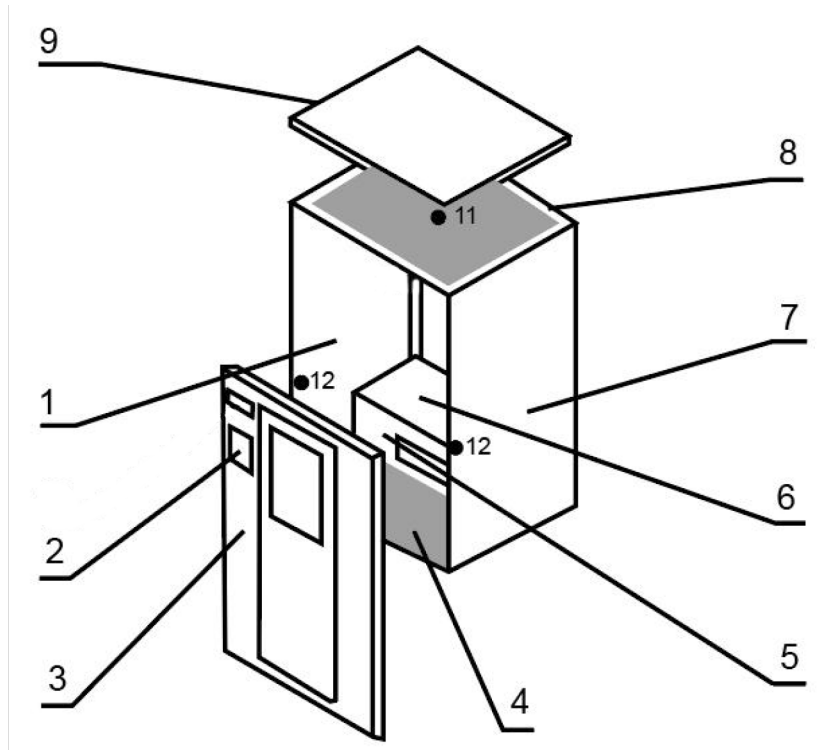

- | | | |
|-----------------|--------------------------|----------------|
| 1. Left Panel | 2. Digital control panel | 3. Front Panel |
| 4. Bottom Panel | 5. Bench Heater Panel | 6. Bench Panel |
| 7. Right Panel | 8. Back Panel | 9. Top Panel |
| | 11. Light | 12. Cup holder |

Installation Information

DO NOT PLUG OTHER APPLIANCES ON THE SAME OUTLET AS YOUR SAUNA

- This sauna must operate on an independent 20 amp circuit
- This sauna must be installed on level ground
- The sauna can only be placed indoors FOR INDOOR USE ONLY
- Do not spray the exterior of the sauna with water.
- If the floor is damp install a floor separator/mat to keep the sauna dry.
- Do not store flammable objects near the sauna.

Assembly Instructions

As mentioned on page 7, to safely assemble your Cal Sauna at least two adults are needed to move and assemble all the provided panels. Please read these instructions thoroughly to ensure proper installation. If you encounter any issues with your Cal Sauna, please call your dealer, or call our customer service phone number.

1-800-225-7727

Monday-Friday
8AM-4:30PM PST
Excluding Holidays

I. How to assemble the sauna with External Buckles

Placing the Bottom Panel

Place the bottom panel on the ground and make sure that the “FRONT” sticker is facing the direction where the front door of the sauna is going to face.



Connecting the Back Panel to Bottom Panel

Place the “Back Panel” on the bottom panel by lining up the wall to the groove on the base. Align the back panel and keep upright, the wall will not be supported until the side panels are aligned and buckled.



Connecting Left Panel

Proceed with the “Left Panel”, align and clip together with the rear panel. The panel label should be placed on the left side when facing the sauna from the front. Ensure that all latches are fastened before moving to the next steps.



Buckle Open



Buckle Fastened

Installing Bench Heater Panel

Slide the bench heater panel between the vertical wooden guides found on each side panel.

- 1- The bench heater panel must be placed so that the "TOP" sticker is facing up with the heater facing towards the front of the sauna.
- 2- Be careful not to scratch the side panels when positioning the heater panel.



Plugging Bench Heater Cable

Connect both the male and female connectors for the bench heater. Make sure the connection is secure.



Installing Bench Panel

Install the "Bench Panel" by sliding it over the horizontal guides on each side panel. Be careful not to scratch the wall panels when doing so.

Make sure to position the bench so that the "BACK" sticker is facing back. The smoother finish side of the bench should be facing upwards, with finished sides on the front. Use 3 of the provided M5 screws to install.



Connecting Right Panel

Place the "Right Panel" on the base, remember to line up the wooden channel guides for the bench heater before latching the wall into position. The right panel should be placed on the right side when facing the sauna in the front.



Connecting Right Panel

Secure the sauna backrest to the rear panel. Use 4 of the provided M5 screws to mount.



Connecting Front Panel

Place the front glass panel, this panel has the most weight and will require two or more people to line up and clip shut. DO NOT LET GO OF THE FRONT PANEL UNTIL SECURED.



Placing Top Panel

To install the top panel, its recommended to open the front glass door for access.

- 1- Put the top panel on top with a second person
- 2- Guide all internal wires through the holes on the bottom of the top panel.
- 3- Once wires are fed through shift the top panel to the left and to the right to ensure the top panel is resting flat on the top of the sauna.

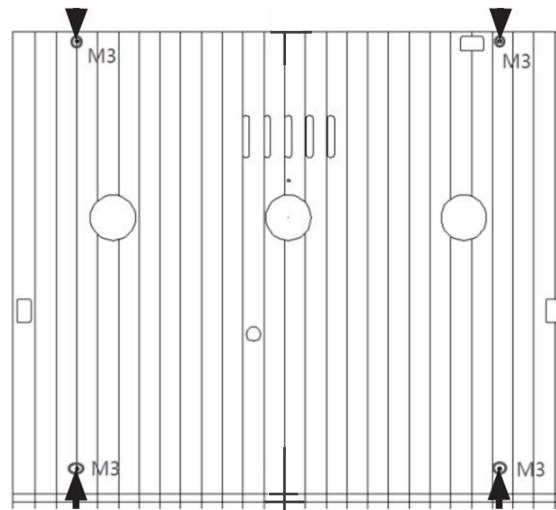

Note: In the following page in the steps ahead, use this diagram to place your top panel screws.

Power Supply Connections

Once the various connections feed through, begin connecting all of the sauna cables to the cables exiting the PCU/Power Control box. ensure to place your ambient temp sensor to the circled illustration for proper mounting.

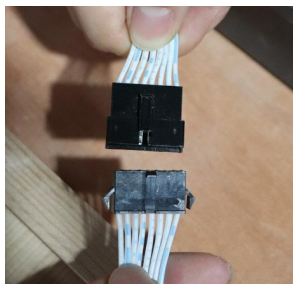

Fastening the Top Panel

Place the top panel enclosure on top of the sauna, and feed the main power cord through the cut hole on the top. Use the provided M3 screws to secure the enclosure to the top panel, 4 screws in total, refer to diagram Pg 14.

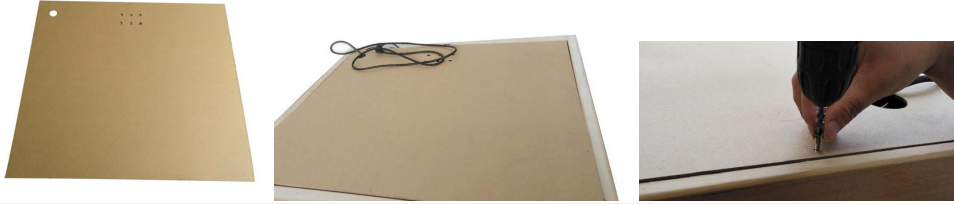

Cup Holder

Attaching the cup holder requires 2 M3 screws, it is advised to use a level to position the cup holder correctly. There is no recommended position on how high or low the Cup Holder should be, but most individuals are comfortable with about 3.5' - 4' feet from the bottom of the sauna, drilled or screwed on by hand onto its right and left side panels.



DOORKNOB INSTALLATION

Install the door handle, feed the screw through the handle, use a Philips screwdriver.



Congratulations, you have finished assembling your Cal Sauna, enjoy adding heat therapy as a part of your routine.

●●● Digital Control Operating Instructions

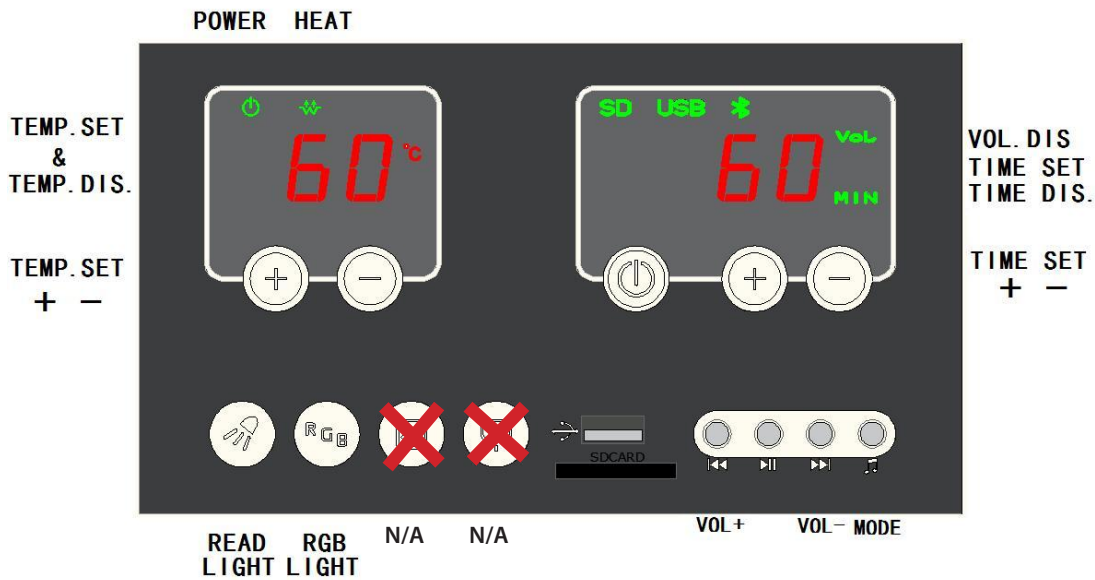

Button and Indicator	Function
Temperature “+ / -” button	Use the “+,-” to raise and lower your preferred temperature. You may hold down the button to raise or lower the temperature setting faster.
Time “+ / -” button	Use the “+,-” buttons to increase the amount of time the sauna has to reach operating temperature. Hold down the buttons to change.
“Read” light button	Press this to turn on the reading light inside of your sauna. Press and hold for 3 seconds to turn off.
“RGB” light button	The LED inside of your Cal Sauna is equipped with RGB, showcase your sauna or set the mood. Press this button repeatedly to cycle through colors.

Stereo Speaker System

Prev	Press to play previous song, long press to increase the volume.
Pause	Press to play or pause your music.
Next	Press to play the next song, long press to decrease the volume.

Mode	Choose SD card, USB, and Bluetooth
Indicator	"Power" light: starting up status. "Heat" light: Lights up when heated. "C"/"F" light: Displays the current temperature mode.

1. Sauna Start Up

- 1- Plug the saunas three prong connector to a dedicated outlet, ensure that the circuit is designed to handle up to 20 amps.
- 2- Once connected, enter the sauna and press the "power" button to activate the control panel and heaters.
- 3- Once turned on, set your sauna timer to 60 minutes at 149F, your sauna will now begin to heat up and reach 149F, allow the sauna to pre-heat for 60 minutes.
- 4- After one hour has passed, enter the sauna and select the amount of time you would like the sauna session to last.

2. Operating the Sauna

- 1- Setting Sauna Temperature
Press the "+" or "-" symbols under the temperature display to adjust/set your temperature,
- 2- Setting Operation Time
Press the "+" or "-" buttons below the temperature display. Once this timer falls to zero an audible beep will occur. You can press the "+" or "-" buttons after the beep to reactivate the sauna.
- 3- The sauna contains an on board memory, it will remember your last set time and temperature for easy restart.
- 4- Remember, the sauna needs to complete a 60 minute warm up cycle to get the sauna up to temperature, once you hear the beep of the timer ending, enter the sauna and press the "+" button to start a new 60 minute cycle to use your sauna.

3. Reading Light

Press the "Light" icon on the bottom left of the controller to turn on your sauna interior light.

4. Switching Between F° and C°

Press the temperature "+" and "-" key together once to switch between F° and C°

5. Turning off the Sauna

Press the "Power" button on the sauna controller to turn off the sauna. If you do not intend on using the sauna for a week or more, disconnect the unit.

6. Continuous Operation

To extend the lifespan of the saunas carbon heaters and heating elements, limit continuous operation for up the 3 hours with 30 minutes of non-operation periods in between .

7. Audio System

- 1 - PREV: Press this to play the previous track, long press to increase the volume from a scale of 0-15.
- 2 - PAUSE: Press to play or pause your music.
- 3 - NEXT: Press this to play the next song, long press to decrease volume from a scale of 0-15.
- 4 - MODE: Switches the source of your music from either an SD card, USB, or Bluetooth. When connecting via Bluetooth, the speakers will appear on your mobile device as "audio". Press the mode button to wake up the system for discovery mode.

NOTE: This sauna does not support Bluetooth phone calls.

8. Lighting RGB Control

The reading light inside of your sauna has RGB capabilities.

- 1 - To begin first power on the lights by pressing the light button
- 2 - Press the RGB button, a total of 7 colors can be selected, red, orange, yellow, green, cyan, blue, & purple. Long press the button to begin cycling through them.
- 3 - to power off the light hold the "Light" button for 3 seconds.

9. Trouble Codes

Sensor codes: The sauna uses a temperature probe to monitor the internal temperature of the sauna, if this temperature probe is damaged in any way you will see on the display "----" indicating no data coming from the sensor. This can be due to a loose connection or a damaged sensor.

●●● Tips for Use

- 1 - To regulate the temperature inside the sauna during your session, use the roof vent of the door window (by setting it at an angle).
- 2 - The sauna has an interior vent to help regulate interior temperature, you can open or close this vent based on your needs.
- 3 - Hydrate yourself before, during, and after sauna use.
- 4 - Use a folded towel as a cushion to sit inside of the sauna, this also helps absorb sweat to keep your sauna clean.
- 5 - Take a lukewarm rinse before using the sauna to help promote sweating.

Additional Sauna Safety

- 1 - Do not install this sauna near a body or open source of water, or in a humid/damp area.
- 2 - Do not use liquid detergents/cleaners inside the sauna. Use only water and a towel to wipe down the inside of sauna. Unplug the sauna before cleaning.
- 3 - Secure the saunas power cord away from any path or walking areas to avoid a trip hazard.
- 4 - Use only authorized Cal Sauna replacement parts, as these parts are designed to run at the specific voltage and amperage of the unit. Using 3rd party components may damage the power supply or cause damage, which would not covered under warranty.
- 5 - DO NOT USE EXTENSION CORDS OR SURGE PROTECTORS FOR THIS SAUNA.
Only use a dedicated circuit for your sauna of 20 Amp
- 6 - Do not consume open beverages inside of the sauna, to avoid spilling liquids on the carbon heaters.

This Page is Intentionally Blank

Resetting the Internal Fuse

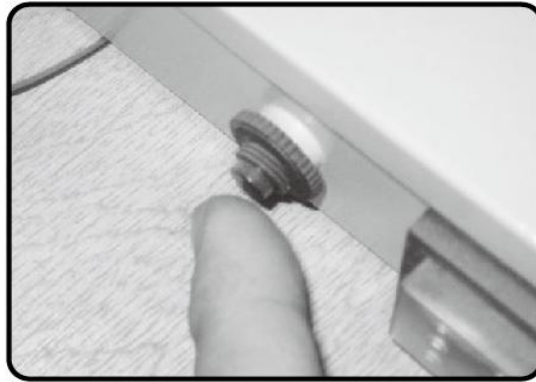

The sauna has an internal fuse that can be reset on the outside of the control box. If a situation occurs where the unit were to trip due to a power surge or a short circuit, remove the top lid of the sauna to access the power control box. Press the button once to reset.

Circuit Diagram

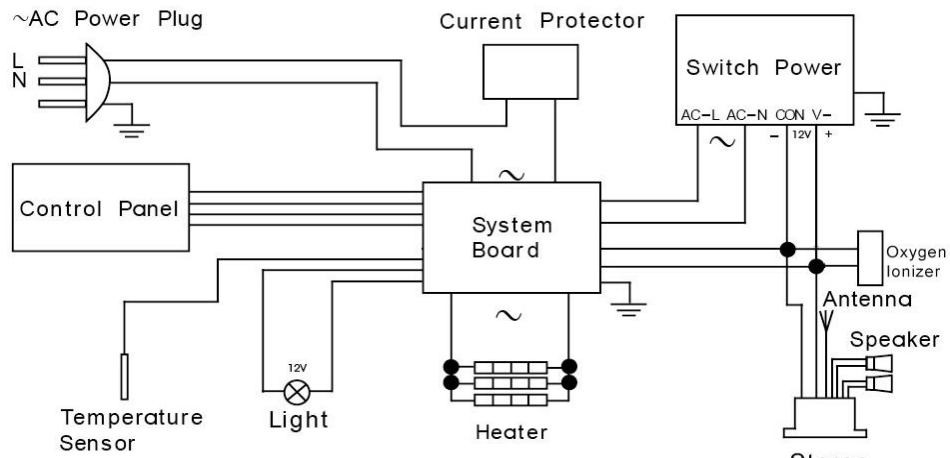

LIMITED WARRANTY

This Limited Warranty is extended to the original purchaser of the sauna distributed by Lloyd's Material Supply Company, Inc. Which distributes Cal Sauna branded saunas after January 1st 2024 and assembled/installed for indoor residential use in the Unites States of America and Canada. This warranty begins on the date of delivery of the sauna, and no later than 90 days after delivery. This warranty is void if the sauna is placed, installed, or operated outdoors. or used for commercial purposes.

Structural

Warrantied against defects in materials affecting the balance/locking of wall panels. 1 Year

Electrical

Warrantied against failure of Power Unit or Control panel due to defects in materials. 1 Year

Carbon/IR Heater

Electrical equipment components - Specifically limited to the IR heater and carbon heaters are warrantied against malfunction due to defects in materials. 1 Year

Warranties on Other Components

Fuses, cables, and the internal LED light are warrantied against defects in materials at time of delivery. Accessories offered with Cal Saunas, cup holders, towel racks, magazine racks, and door handles are warrantied for one year from day of arrival. Saunas equipped with an audio system carry a one year warranty against defects in materials from the date of arrival in regards to the speaker and amplifier. All other components not mentioned in this warranty are not covered under this Limited Warranty.

Genuine Cal Sauna Components

This Limited Warranty is voided if Lloyd's Material Supply Company .Inc or a designated representative determines that the sauna was subjected to damage of encountered an operational failure due to installation of aftermarket or 3rd party components that are not genuine Cal Sauna authorized parts and accessories. This disclaimer includes but is not limited to, IR heaters, carbon heaters, LED lights, power unit, power cords, replacement parts and accessories. Genuine Cal Sauna components are designed to operate with your Cal Sauna to ensure proper performance of the sauna.

Performance

This warranty begins on the date of delivery of the sauna, but in no later event than 90 days from the date of arrival. To obtain service in the event of a malfunction or defect covered by this limited warranty, notify your Cal Sauna dealer or Cal Sauna as soon as possible, use all reasonable means to protect the sauna from further damage. Upon providing proof of purchase to your dealer, a designated service representative will authorize the order of new components, to repair the defective components in accordance to the terms and conditions contained in this warranty. There will be no charge for the cost of parts to repair the defect. Freight charges, labor fees, diagnose and travel fees are not covered by this limited warranty.

In the event the sauna is removed from the property to a repair facility and reinstalled, the cost of removal and re-installation will be the responsibility as the spa owner. If Lloyd's Material Supply Company .Inc, the distributor of Cal Sauna determines that the repair of the defect is not feasible, it reserves the right to provide a replacement sauna of equal or lesser value to the original purchase price. In such an event reasonable costs for removal of the original sauna, shipping costs to transport the defective unit or replacement unit, will the responsibility of the sauna owner. The replacement sauna will carry the balance of the original saunas warranty. This warranty ends by either the specified time frame, ownership transfer, relocation, or installation of other components not authorized by Cal Sauna.

Warranties on Other Components

This Limited Warranty is void if Cal Sauna or its designated representative determines that the sauna has been subjected to alteration, neglect, misuse, or abuse, exposure to the outdoors, exposure to water or moisture, freight damage caused by the common carrier; any repairs attempted by anyone other than a designated representative or general technician. This warranty is void due to failure caused by accident, acts of God or other causes beyond the control of Cal Sauna including acts of nature (damage caused by animals, rodents, or other pests) are not covered by this warranty, additionally; neglect, misuse and abuse include any installation, operation or maintenance of the sauna other than in accordance with the instructions contained in the owner's manual. The use of improper cleaners or non-genuine parts and accessories will void this Limited Warranty. This Limited Warranty does not provide coverage for any item attached to or installed on the spa after the date of manufacture.

Disclaimers

Lloyd's Material Supply Company, Inc, the Cal Sauna brand and its representatives shall not be liable for any injury, loss, cost, or other damage whether incidental or consequential, arising out of any defect covered by this limited warranty, including without limitation, loss of use of the sauna and cost for removal of defective produce even if Cal Sauna was advised of the possibility of damage. The liability of the manufacture and distributor under this limited warranty, if any shall not exceed the original amount paid for the defective product. Coverage under this limited warranty shall commence as of the original date of delivery and the duration of such coverage shall not extend for any reason whatsoever beyond the states time periods. These disclaimers shall be equally applicable to any service provided by the manufacture or distributor and its designated representatives.

Legal Rights

This limited warranty give you specific legal rights. You may also have other rights that vary from state to state. Some states do not allow limitations on how long an implied warranty lasts, so this limitation may not apply to you.

For your record, please complete the following information.	
Date of Purchase	
Date of delivery	
Model Number	
Serial number	
Dealer Information (Name & Phone)	

